



ENGINE		FRAME	
SERVICE INFORMATION	3-1	BATTERY	3-9
AIR CLEANER	3-2	BRAKE FLUID LEVEL	3-9
CRANKCASE BREATHER	3-3	BRAKE FLUID	3-10
FUEL LINE	3-3	BRAKE SYSTEM	3-11
SPARK PLUG	3-3	HEADLIGHT AIM	3-13
VALVE CLEARANCE	3-4	CLUTCH FREE PLAY	3-13
CAM CHAIN	3-5	SIDE STAND	3-14
THROTTLE OPERATION	3-5	SUSPENSION	3-14
IDLE SPEED	3-6	WHEELS	3-15
CARBURETOR CHOKE	3-6	STEERING HEAD BEARING	3-15
CARBURETOR SYNCHRONIZATION	3-7	NUTS, BOLTS, FASTENERS	3-15
COOLANT	3-8		
COOLING SYSTEM HOSES	3-8		
RADIATOR CORE	3-8		

SERVICE INFORMATION

• WORKING PRACTICE

ENGINE OIL LEVEL	Refer to Page 2-2
ENGINE OIL & OIL FILTER CHANGE	Refer to Page 2-2
FINAL DRIVE LUBRICANT	Refer to Page 2-3
DRIVE SHAFT JOINT	Refer to Page 2-3

• SPECIFICATIONS

ENGINE

Spark plug gap: 0.6-0.7 mm (0.024-0.028 in.)
 Spark plug type: USA model

Canadian model
 ND X24ESR-U, NGK DR8ES-L

For cold climate below 5°C (41° F)		Standard		For extended high speed riding	
ND	NGK	ND	NGK	ND	NGK
X22ES-U	D7EA	X24ES-U	D8EA	X27ES-U	D9EA

ENGINE

Ignition timing	
"FL" mark	: 15° BTDC at 1,100 rpm
Ignition advance	: 37° BTDC at 5,500-6,000 rpm
Valve clearance	IN : 0.08 mm (0.003 in.)
	EX : 0.10 mm (0.004 in.)
Throttle free play	: 2-6 mm (0.08-0.24 in.)
Idle speed	: 1,100 ± 100 rpm
Vacuum pressure difference	
between carburetors	: 40 mm (1.6 in.) Hg
Fast idle speed	: 1,500-2,500 rpm
Compression	: 12 ± 2 kg/cm ² (171 ± 28 psi.)
Clutch free play	: 10-20 mm (3/8-3/4 in.)

CHASSIS

Rear brake pedal free play	: 20-30 mm (3/4-1-1/4 in.)
Tire pressures:	
Rider only:	
Front	: 1.75 kg/cm ² (25 psi.)
Rear	: 2.00 kg/cm ² (28 psi.)
Rider and passenger:	
Front	: 1.75 kg/cm ² (25 psi.)
Rear	: 2.50 kg/cm ² (36 psi.)

• TORQUE VALUES

Front axle nut	: 5.5-6.5 kg-m (40-47 ft-lbs)
Front axle nut holder	: 1.8-2.5 kg-m (13-18 ft-lbs)
Rear axle nut	: 5.5-6.5 kg-m (40-47 ft-lbs)



AIR CLEANER

Remove the seat.
Remove the air cleaner cover by turning it counterclockwise.

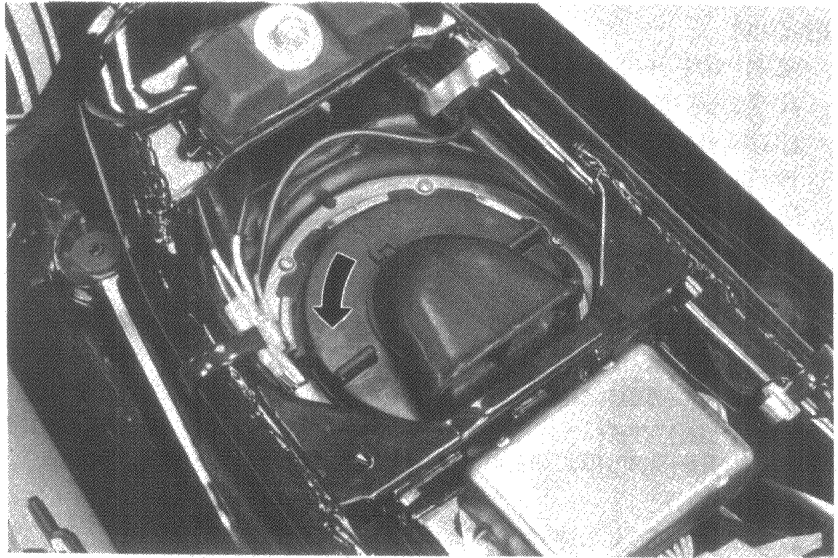

Remove the air cleaner element.

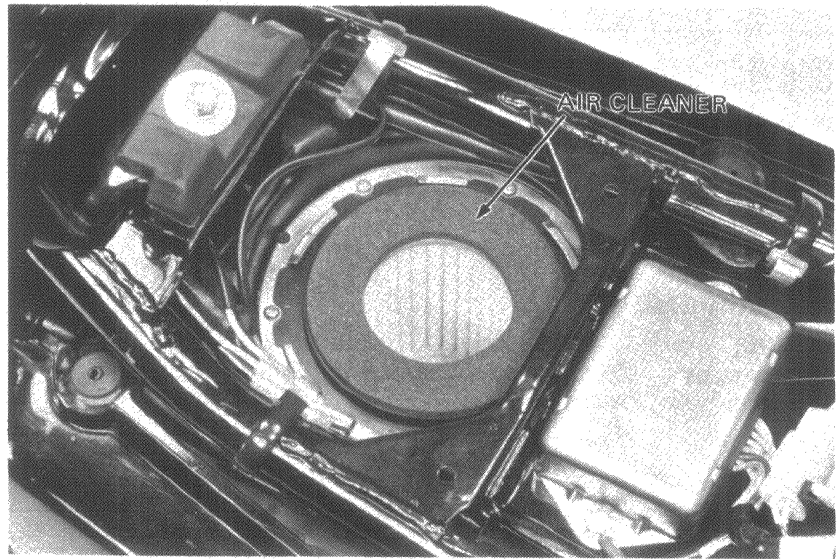

Clean the air cleaner element by tapping it lightly to loosen dust. Remove the remaining dust with compressed air. Replace if necessary.

NOTE

Install the cover with the "TOP" mark facing the front.

Install element and cover. Install seat.

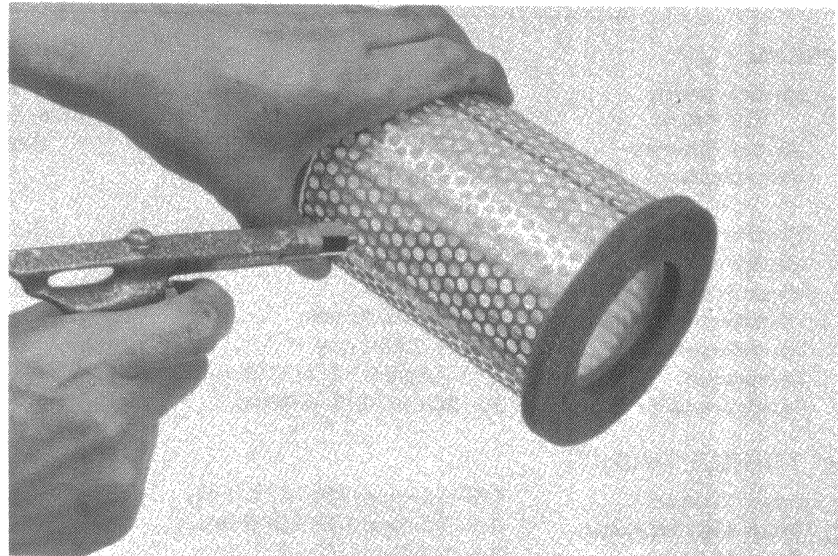



CRANKCASE BREATHER

Remove the two drain plugs from the tubes, and drain deposits.
Install the two drain plugs.

NOTE

Service more frequently when driven in rain, or full at throttle openings, dropped or washed often. Service if the deposit level can be seen in the transparent section of the drain tubes.

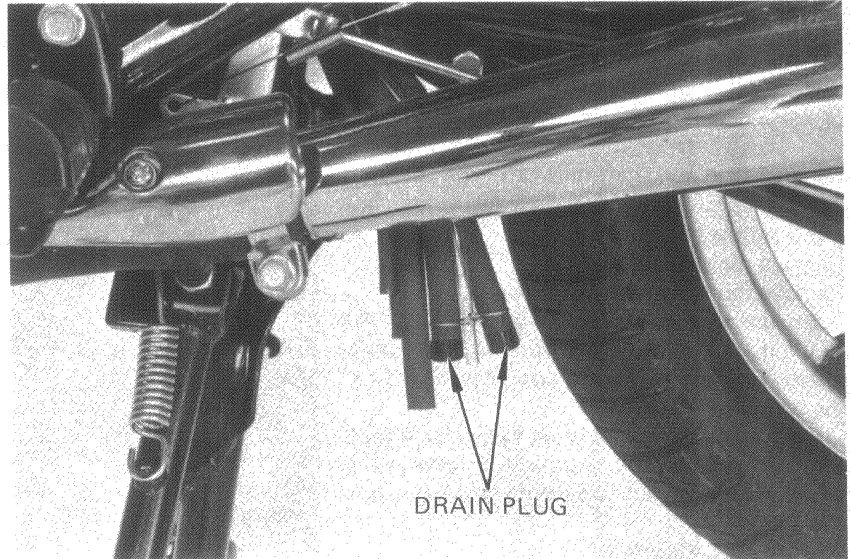

FUEL LINE

Make sure that the fuel lines and connections are not deteriorated, damaged or leaking. Replace any parts which have deterioration, damage or leakage.

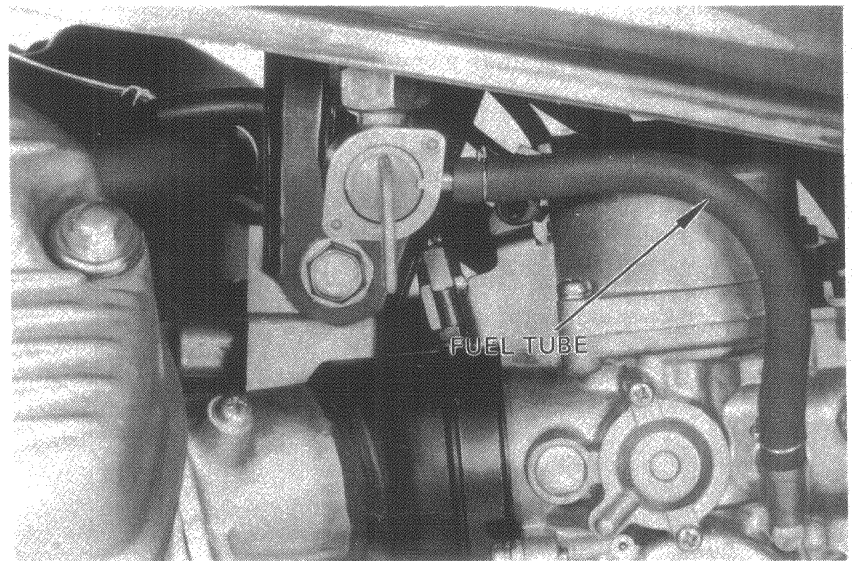

SPARK PLUG

Disconnect the spark plug cap and remove the spark plug.

Visually inspect the spark plug electrodes for wear. The center electrode should have square edges and the side electrode should have a constant thickness. Discard the spark plug if there is apparent wear or if the insulator is cracked or chipped. If the spark plug deposits can be removed by sandblasting, the spark plug can be reused.

Adjust the spark plug gap by bending the side electrode.

SPARK PLUG GAP: 0.6-0.7 mm
(0.024-0.028 in.)

STANDARD SPARK PLUG:

USA model ND X24ES-U NGK D8EA

Canadian model ND X24ESR-U

NGK DR8ES-L

Check the sealing washer condition.

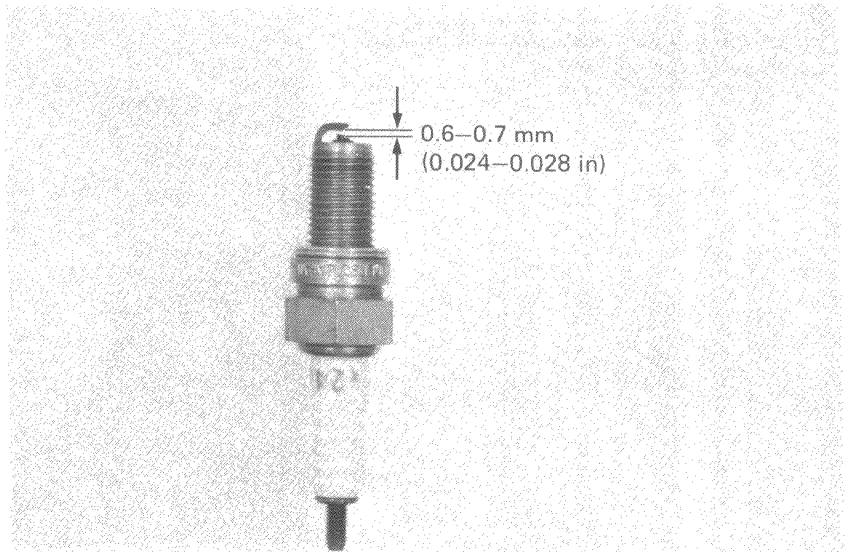



VALVE CLEARANCE

NOTE

This adjustment must be performed while the engine is cold (below 35°C).

Remove the crankshaft hole cap from the transmission cover and the timing inspection hole cap from the rear cover.

Remove the spark plug caps.

Remove the cylinder head covers.

Turn the crankshaft clockwise and align the "TL" mark on the rotor with the pulser index mark. The left cylinder must be at T.D.C. of the compression stroke.

Check the intake and exhaust valve clearance of the left cylinder by inserting a feeler gauge between the clearance adjusting screw and valve stem.

VALVE CLEARANCE

IN: 0.08 mm (0.003 in.)

EX: 0.10 mm (0.004 in.)

Adjust, by loosening the lock nut, and turning the screw until there is a slight drag on the feeler gauge.

Hold the screw and tighten the lock nut.

Recheck the valve clearances. Turn the crankshaft clockwise and align the "TR" mark on the rotor with the pulser index mark. The right cylinder must be at the T.D.C. of the compression stroke.

Check the intake and exhaust valve clearance of the right cylinder as described for the left cylinder.

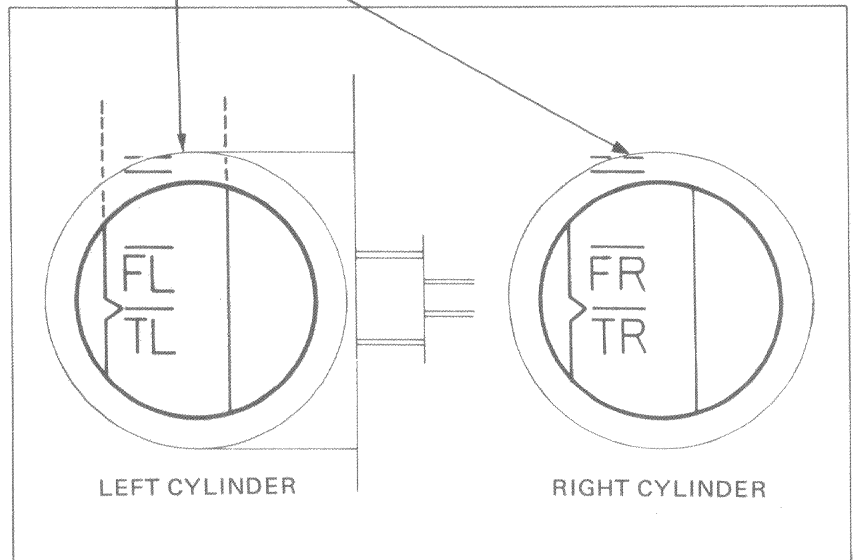
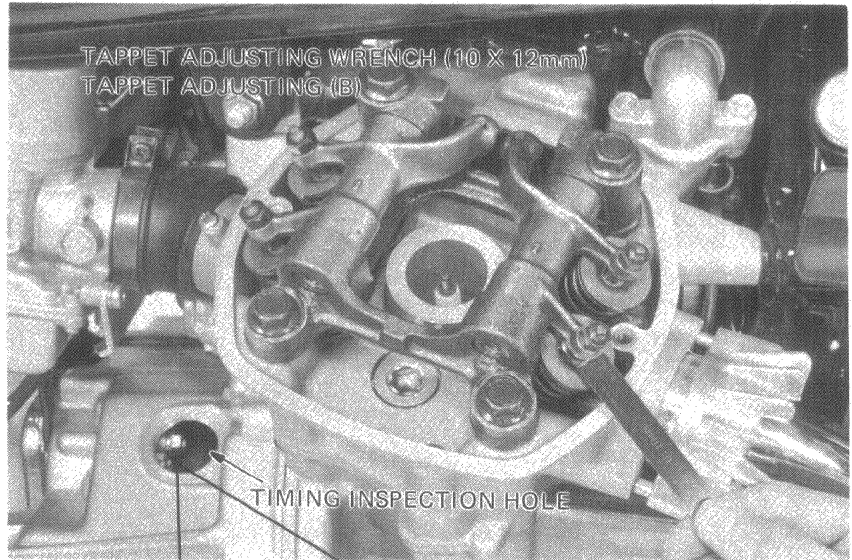

NOTE

Coat the cylinder head cover bolt rubbers with oil before tightening.

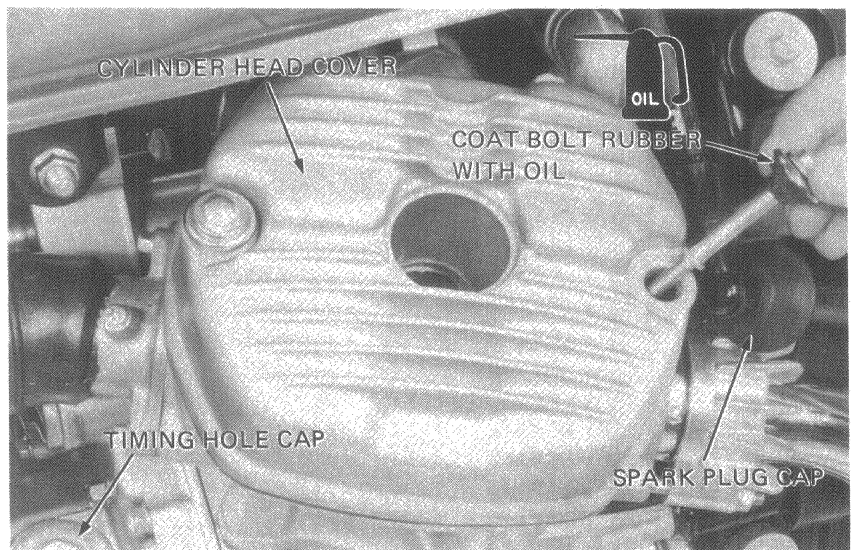



CAM CHAIN

Remove the left cylinder head cover.
 Remove the crankshaft and timing hole caps from the transmission and rear covers respectively.
 Slowly turn the crankshaft clockwise and align the rotor "TL" mark with the pulser index mark. Be sure the left piston is at TDC of the compression stroke.
 Loosen the cam chain tensioner lock bolt. When this bolt is loosened, the cam chain tensioner will automatically position itself to provide the correct cam chain tension.
 Retighten the lock bolt.

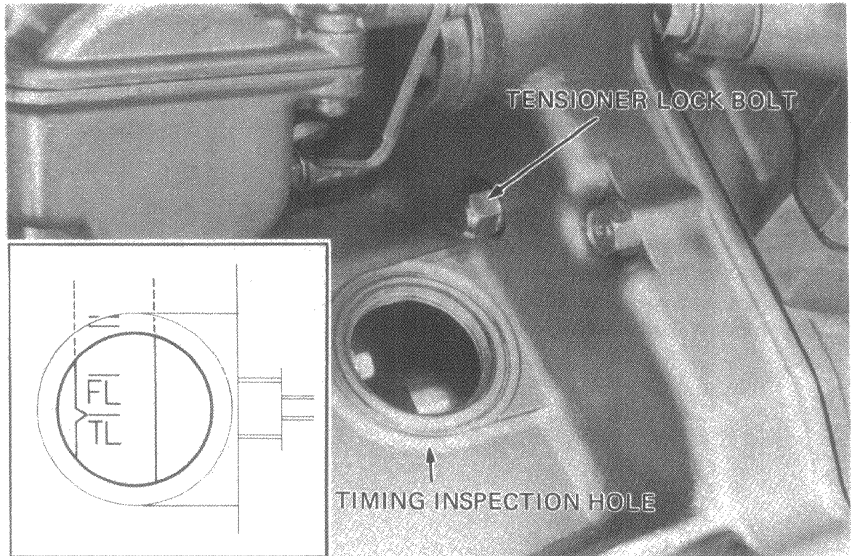

THROTTLE OPERATION

Check that there is no deterioration, damage, or kinks in the throttle cables, and that the throttle grip free play is 2-6 mm (1/8-1/4 in.) on the outer edge of the throttle grip flange.
 Check for smooth throttle grip rotation from fully closed to fully open positions at all steering positions.
 Check that the throttle grip automatically returns from fully open to fully closed position when released.
 Adjust or replace, if necessary.

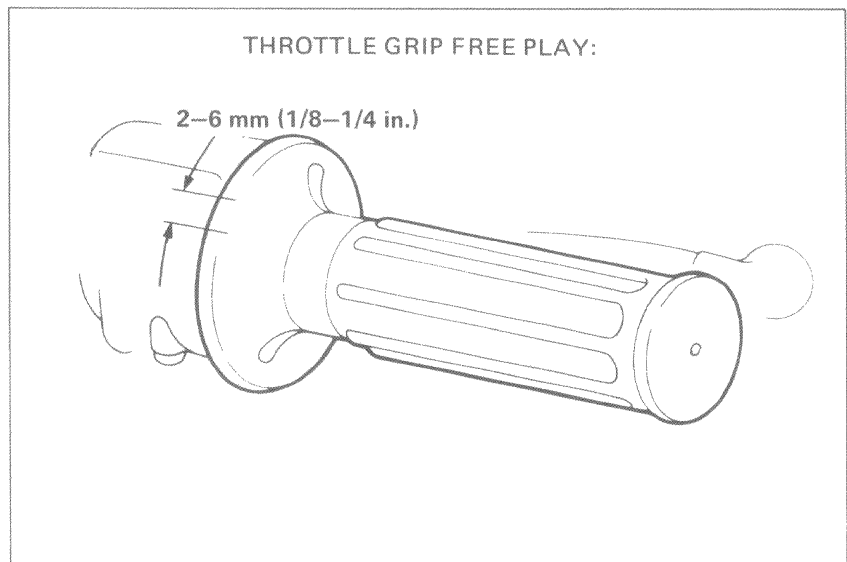

Throttle grip free play can be adjusted at either end of the throttle PULL cable. Major adjustments must be made at the lower adjuster. Adjust by loosening the adjuster lock nut and turning the adjuster. Tighten the locknut. Minor adjustments must be made at the upper adjuster.

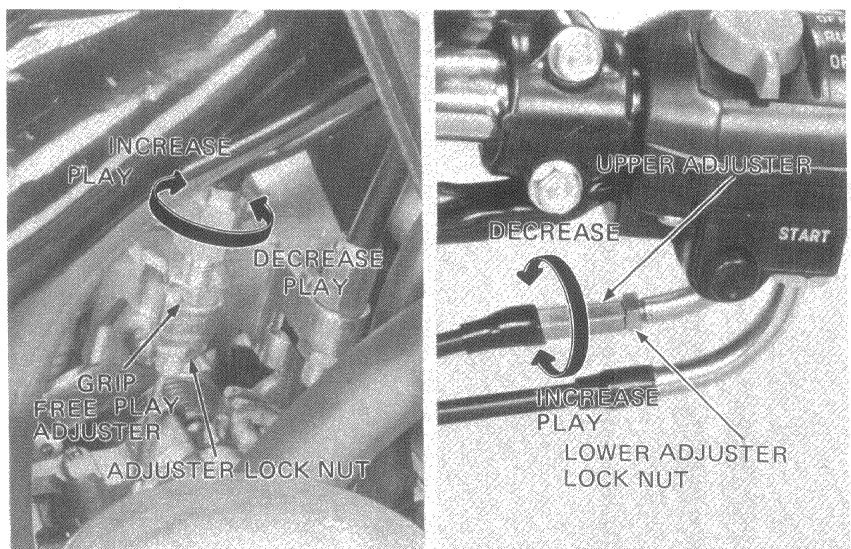



IDLE SPEED

NOTE

The engine must be warm for accurate idle adjustment. Ten minutes of stop and go driving is sufficient, or when the temperature gauge needle is in the wide white line.

Warm up the engine, place the transmission in neutral and the motorcycle on its center stand. Adjust idle speed with the throttle stop screw.

IDLE SPEED: 1,100 ± 100 rpm

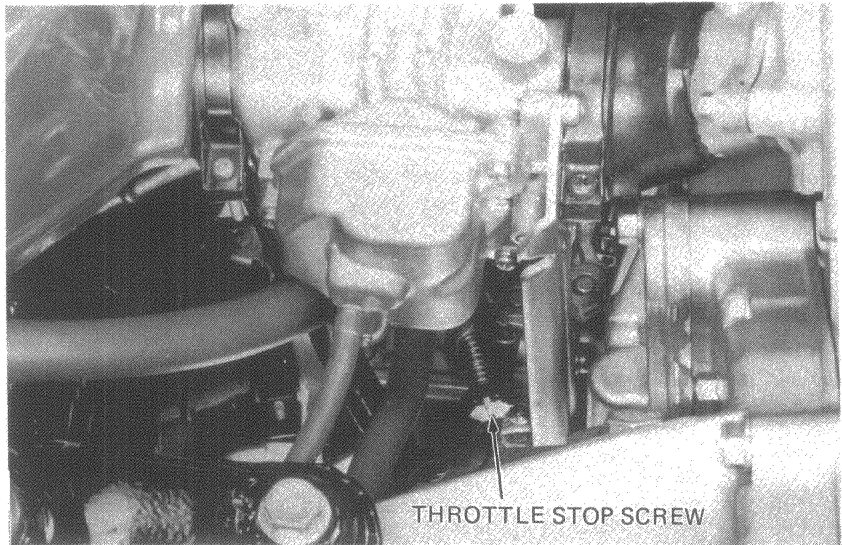

CARBURETOR CHOKE

Operate the choke knob and check for smooth operation.

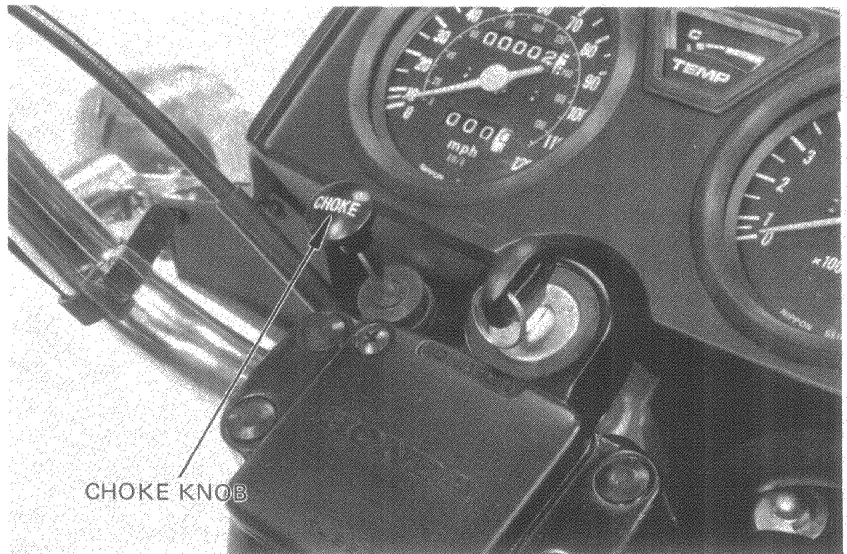



CARBURETOR SYNCHRONIZATION

NOTE

This adjustment is performed with engine at normal operating temperature, transmission in neutral, and vehicle on center stand.

Remove the plugs from the carburetor spacers and install adapters.
Connect the vacuum gauges.

Start the engine and adjust the idle speed to $1,100 \pm 100$ rpm.

The difference of vacuum between cylinders should be within **40 mm (1.6 in) Hg**.

MUST BE WITHIN 40mm (1.6 in) Hg OF EACH OTHER

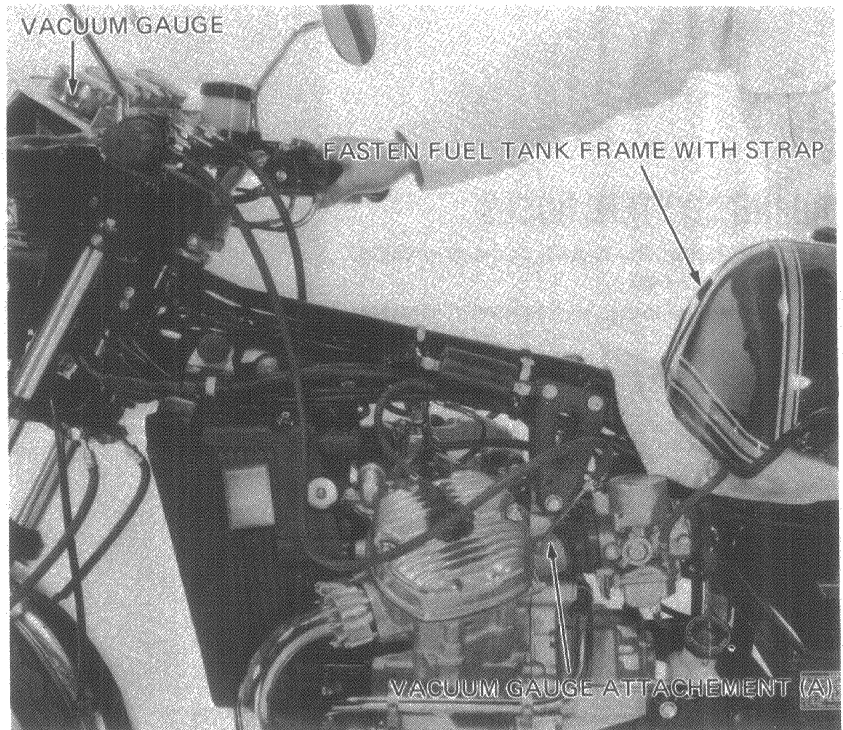
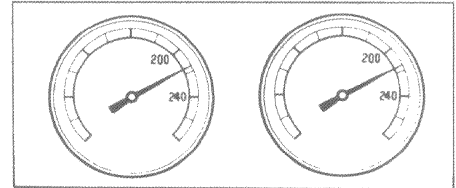

• ADJUSTMENT

Prepare a longer fuel tube and connect it to the fuel tank and carburetor.

Position the tank higher than normal.

Loosen adjusting screw lock nut.

Balance the vacuum between cylinders to within **40 mm (1.6 in) Hg** of each other, by turning the adjusting screw.

Hold adjusting screw, and tighten the lock nut.

Recheck the synchronization and idle speed.

Reinstall the fuel tank and seat.

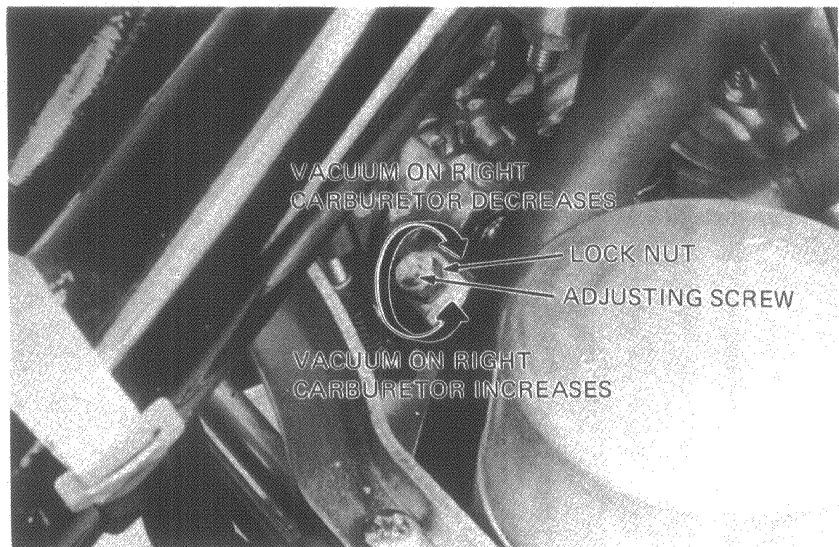



INSPECTION AND ADJUSTMENT

COOLANT

Check the coolant level of the reserve tank with the engine running at normal operating temperature.

The level should be between the "FULL" and "LOW" level lines.

If necessary, remove the reserve tank cap and fill to the "FULL" level line.

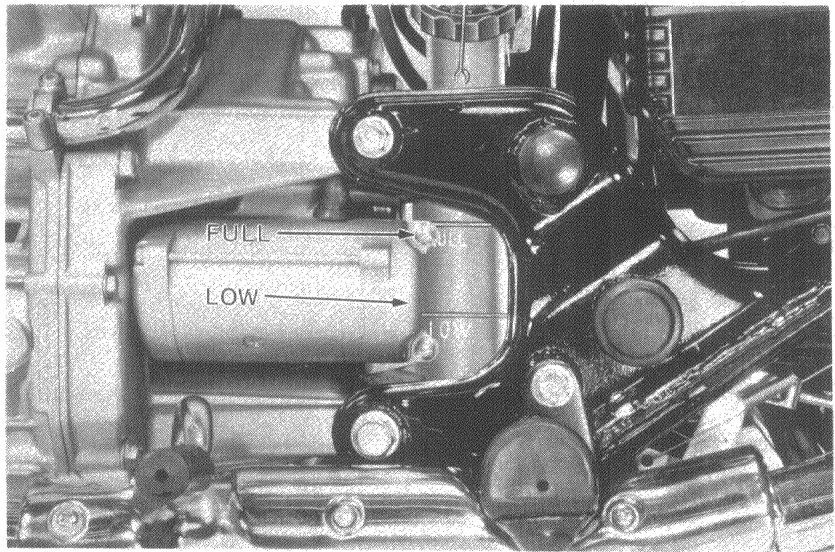

COOLING SYSTEM HOSES

Inspect the hoses for cracks or deterioration, and replace if necessary.

Check the hose clamps, and tighten if necessary.

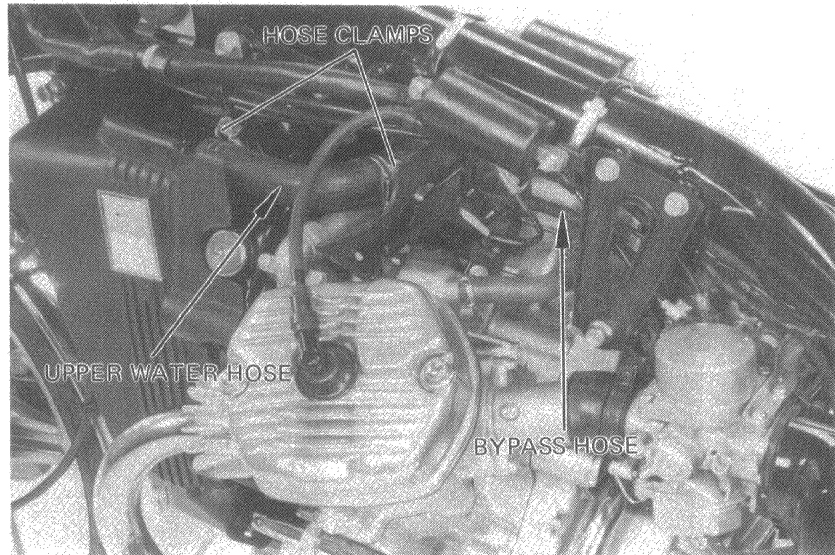

RADIATOR CORE

Check the air passages for clogging or damage. Straighten bent fins.

Remove insects, mud or any obstruction with compressed air or low water pressure.

Replace the radiator if the air flow is restricted over more than 20% of the radiating surface.

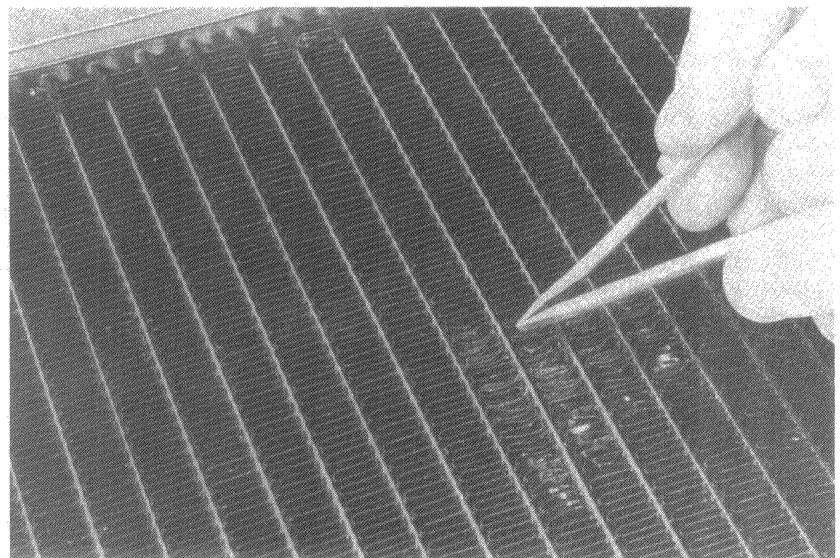



BATTERY

Remove the left side cover.
 Inspect the battery electrolyte level.
 When the electrolyte level nears the lower level mark, fill with distilled water to the upper level mark.
 If sulfation forms on the battery walls or sediments (paste) accumulate on the bottom of the battery, replace the battery.

NOTE

Add only distilled water. Tap water will shorten the service life of the battery.
 Never add more electrolyte.

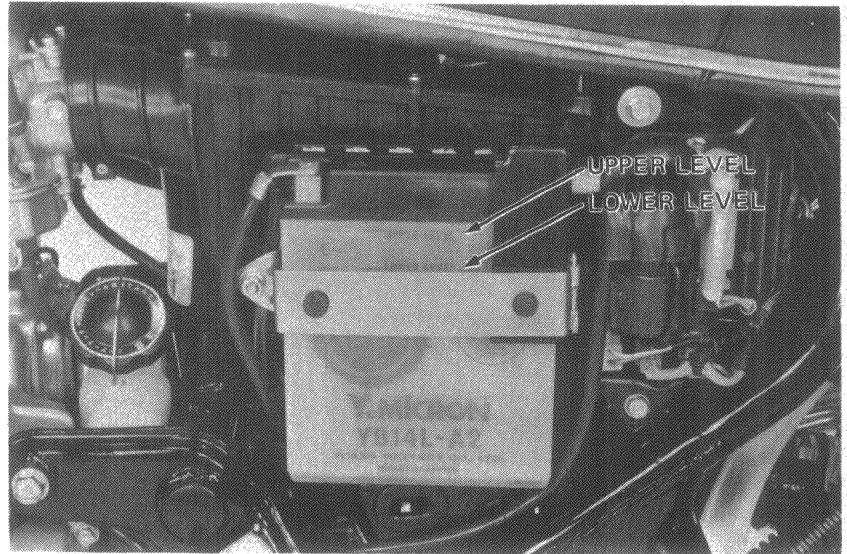

BRAKE FLUID LEVEL

Check that the brake fluid reservoir is filled to the level mark engraved inside the reservoir.
 If the level is lower than the mark, fill the reservoir with DOT-3 BRAKE FLUID up to the level mark.
 Check the entire system for leaks, if the level is low.

CAUTION

- Do not mix different brands of fluid, as they are not compatible.
- Do not remove the cap until the handlebar has been turned full left so that the reservoir is level.
- Avoid operating the brake lever with the cap removed. Brake fluid will flow out if the lever is pulled.



WARNING

The battery electrolyte contains sulfuric acid. Protect your eyes, skin and clothing. In case of contact, flush thoroughly with water and call a doctor if your eyes were exposed.



BRAKE FLUID REPLACEMENT

Check the fluid level with the fluid reservoir parallel with the ground.

CAUTION

Be sure to install the diaphragm on the reservoir when operating the brake lever. Failure to do so will force the fluid out of the reservoir by the system pressure pumped up by the operation of the brake lever.

Avoid spilling fluid on painted surfaces. Place a rag over the fuel tank whenever the system is serviced.

● BRAKE FLUID DRAINING

Remove the bleeder valve dust cap.

Connect a bleed hose and place one end in a clean container.

Loosen the caliper bleeder valve and pump up the system pressure by operating the brake lever/pedal.

Stop operating the lever/pedal when no fluid is flowing out of the bleeder valve.

● BRAKE FLUID FILLING

CAUTION

Check the fluid level often while bleeding the brake, to prevent air from being pumped into the system.

Do not mix different brands of fluid since they are not compatible.

Close the bleeder valve, fill the reservoir, and install the diaphragm.

To prevent piston overtravel and brake fluid seepage, keep a 20 mm space between the lever and the handlebar grip when bleeding the front brake system.

Pump up the system pressure with the lever until there are no air bubbles in the fluid flowing out of the reservoir small hole (until lever resistance is felt).

● AIR BLEEDING

Pull the brake lever all the way back to the handlebar grip. Screw out the bleeder valve about 1/2 turn, and retighten.

NOTE

Do not release the lever until the bleeder valve has been closed.

Release the lever gradually and wait for several seconds after it reaches the end of its travel.

Repeat the above steps until there are no air bubbles in the fluid flowing out of the bleeder valve.

Fill the reservoir up to the UPPER FLUID LEVEL.

Check the entire system for leaks by operating the lever.

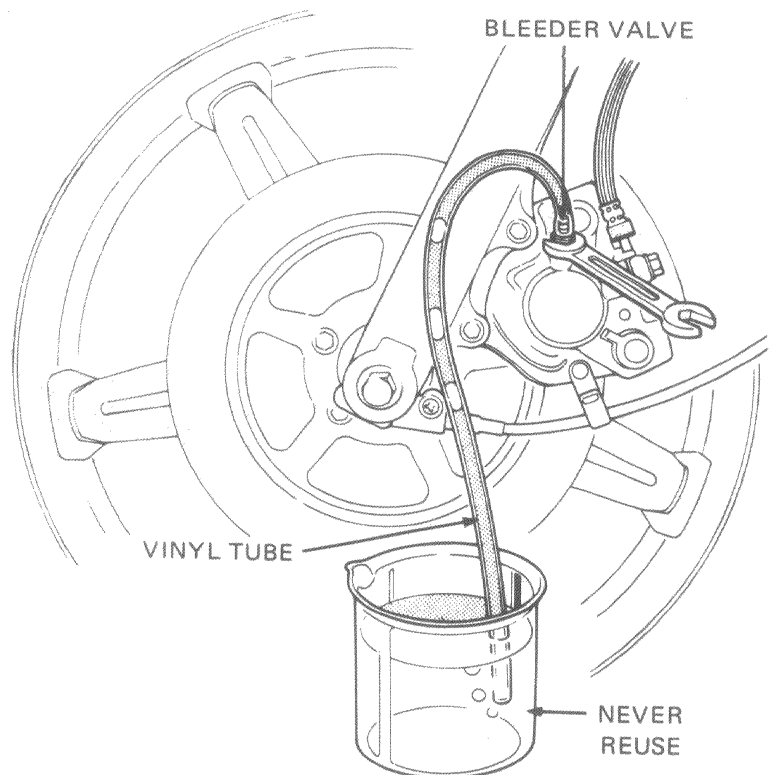
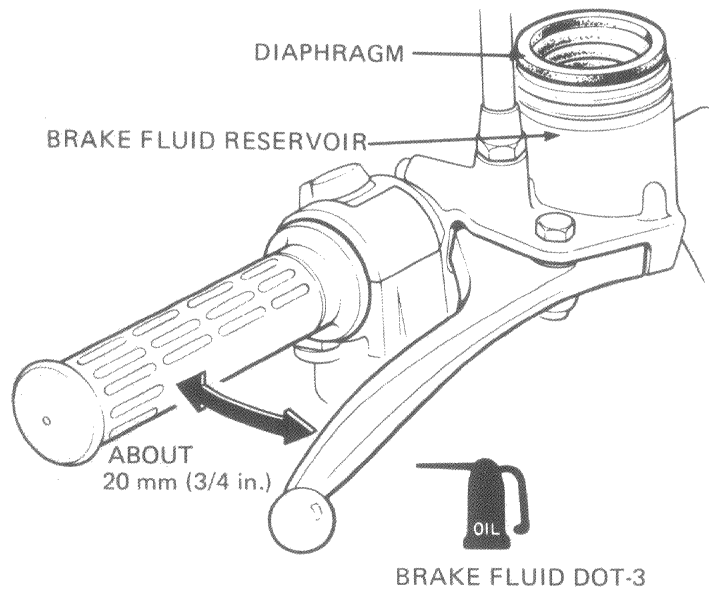

WARNING

A contaminated brake disc or pads reduces stopping power. Replace contaminated pads, and clean a contaminated disc with a good quality degreasing agent.



BRAKE SYSTEM

• BRAKE PAD WEAR

Remove the cap from the caliper and check for brake pad wear.

Replace the brake pads if the red line on the top of the pads reaches the edge of the brake disc (Section 15).

CAUTION

Always replace the brake pads in pairs to assure even disc pressure.

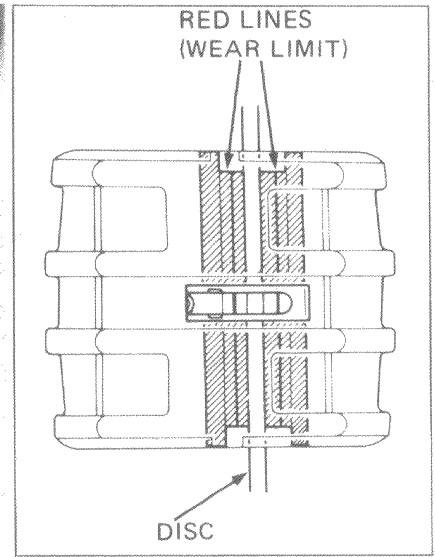
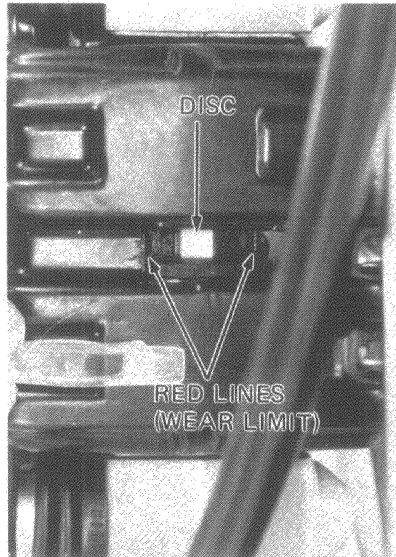

• BRAKE SHOE INSPECTION (WEAR INDICATOR)

Replace the brake shoes if the arrow on the brake arm aligns with the reference mark "△" on full application of the rear brake.

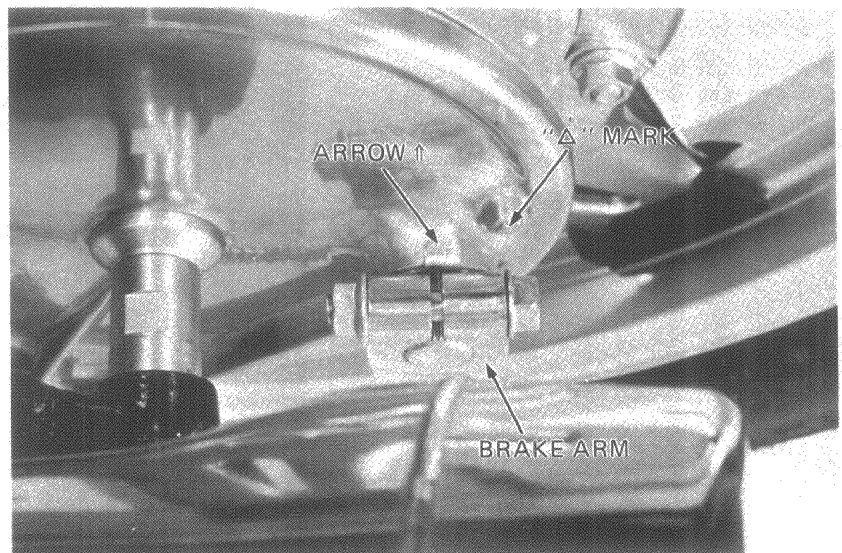

• BRAKE SYSTEM HOSE

Make sure that the brake hose is not deteriorated and check the entire brake system for leaks.

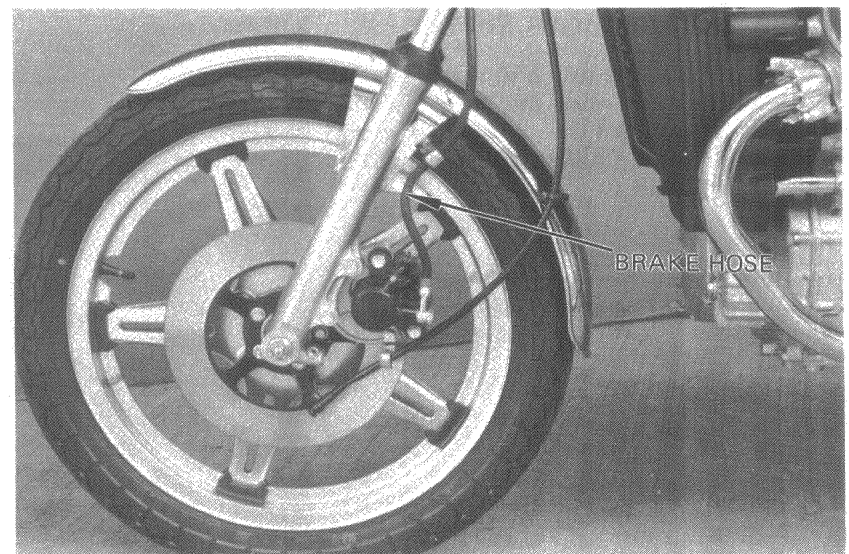



INSPECTION AND ADJUSTMENT

• **BRAKE PEDAL HEIGHT**

Loosen the lock nut.
Adjust the brake pedal height by turning the stopper bolt.
Retighten the lock nut.

NOTE

After adjusting the brake pedal height, check the rear brake light switch and adjust if necessary.

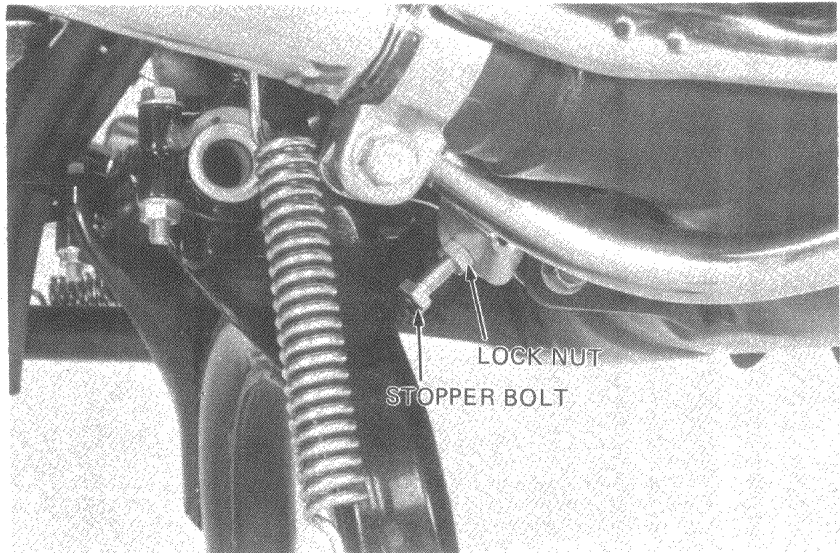

• **BRAKE PEDAL FREE PLAY**

Check the brake pedal free play.
FREE PLAY: 20–30 mm (3/4–1-1/4 in.)
If adjustment is necessary, turn the rear brake adjusting nut.

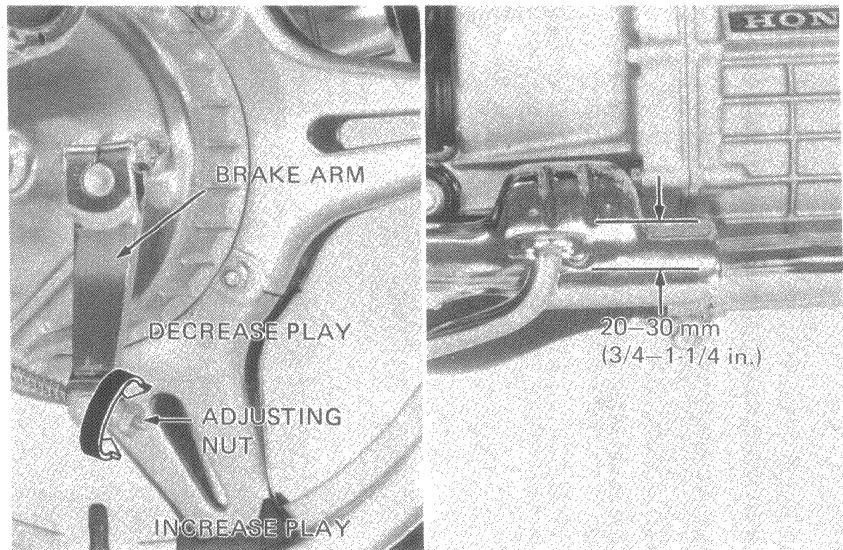

• **REAR BRAKE LIGHT SWITCH**

Adjust the brake light switch so that the brake light will come on when the brake pedal is depressed **20 mm (3/4 in)**, when the brake begins engagement. Adjust by turning the switch adjusting nut.

NOTE

Perform brake light switch adjustment after adjusting brake pedal play and pedal height.

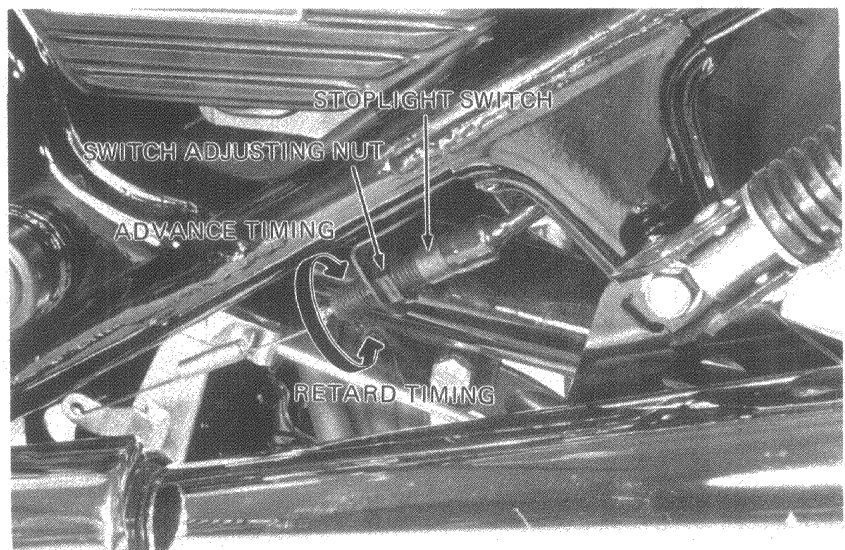



HEADLIGHT AIM

The headlight beam can be adjusted vertically and horizontally.

Adjust vertically by turning the vertical adjustment screw shown.

Adjust horizontally by turning the horizontal adjustment screw shown.

CAUTION

Adjust the headlight beam as specified by local laws and regulations.

WARNING

An improperly adjusted headlight may blind oncoming drivers, or it may fail to light the road for a safe distance.

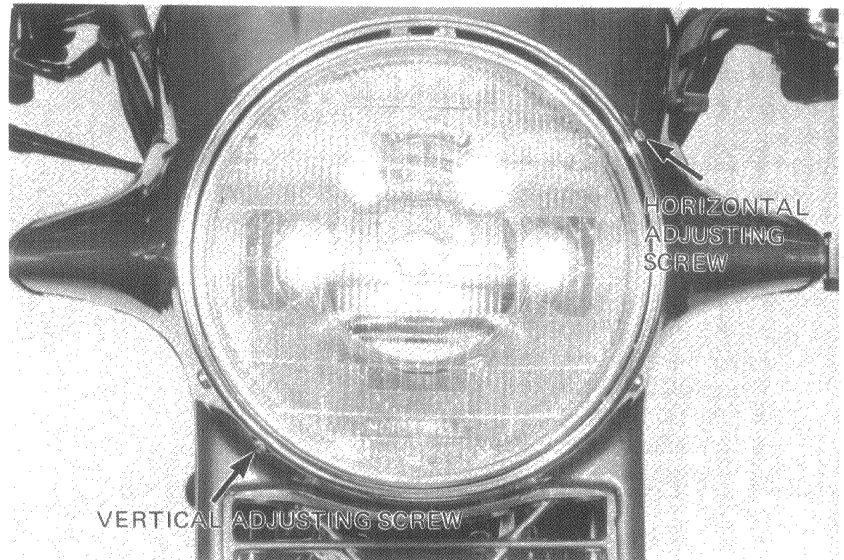

CLUTCH FREE PLAY

Measure the clutch lever free play.

CLUTCH LEVER FREE PLAY: 10-20 mm (3/8-3/4 in.)

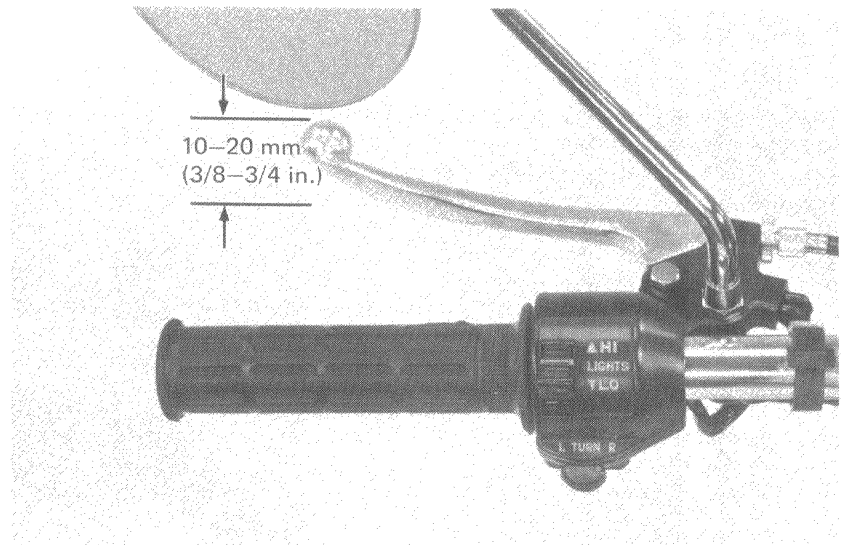

Major adjustments should be made using the adjuster located at the clutch housing. Loosen the lock nut and turn the clutch cable adjusting nut.

Minor adjustments can be made with the clutch cable adjuster located on the clutch lever. Loosen the lock nut and turn the adjuster.

NOTE

Do not allow the threads at the adjuster to come out by more than 8 mm (0.3 in.).

WARNING

Do not burn yourself on the exhaust pipe.

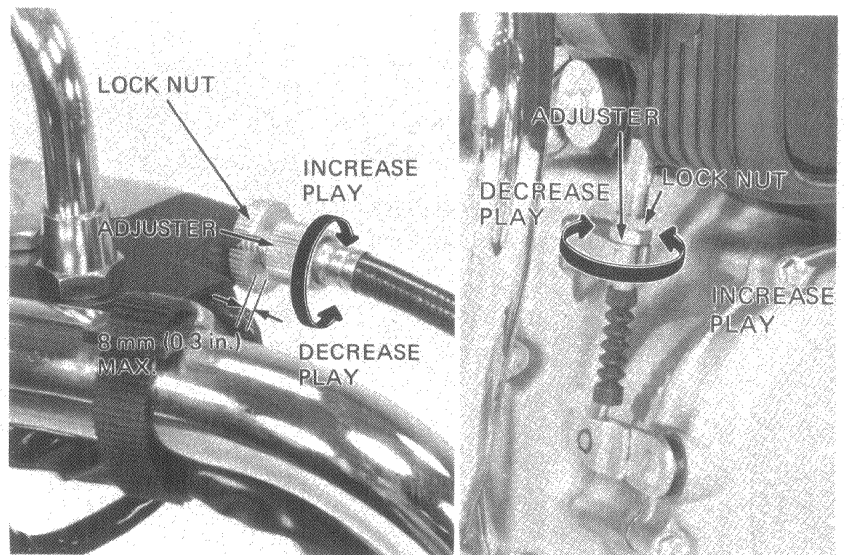

Recheck the clutch operation.



INSPECTION AND ADJUSTMENT

SIDE STAND

Check the rubber pad for deterioration or wear. Replace if any wear extends to wear line as shown.

Check the side stand spring for damage and loss of tension, and the side stand assembly for freedom of movement and bend.

NOTE

- When replacing, use a rubber pad with the mark "Over 260 lbs ONLY".
- Spring tension is correct if the measurements fall within **2-3 kg (4.4-6.6 lb)**.
When pulling the side stand lower end with a spring scale.

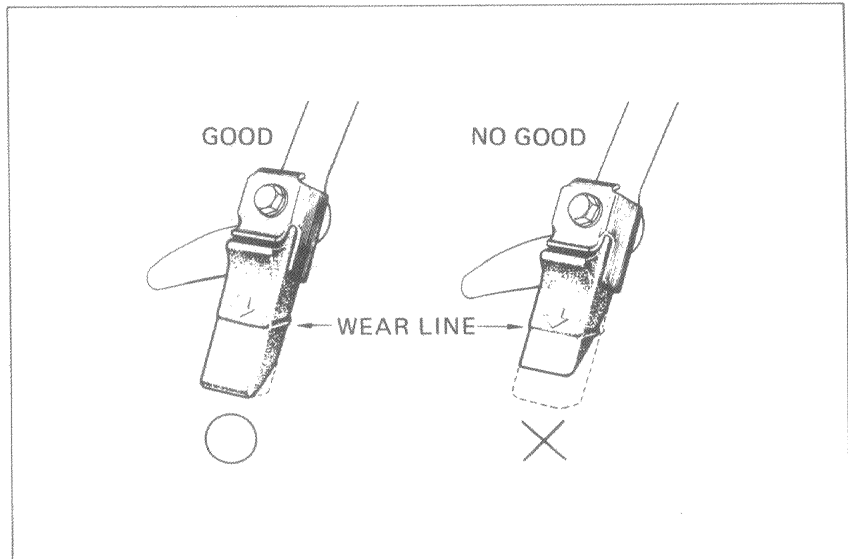

SUSPENSION

• FRONT

Check the action of the front forks by compressing them several times.

Check the entire fork assembly for signs of leaks or damage.

Replace any components which are unrepairable.

Torque all nuts and bolts.

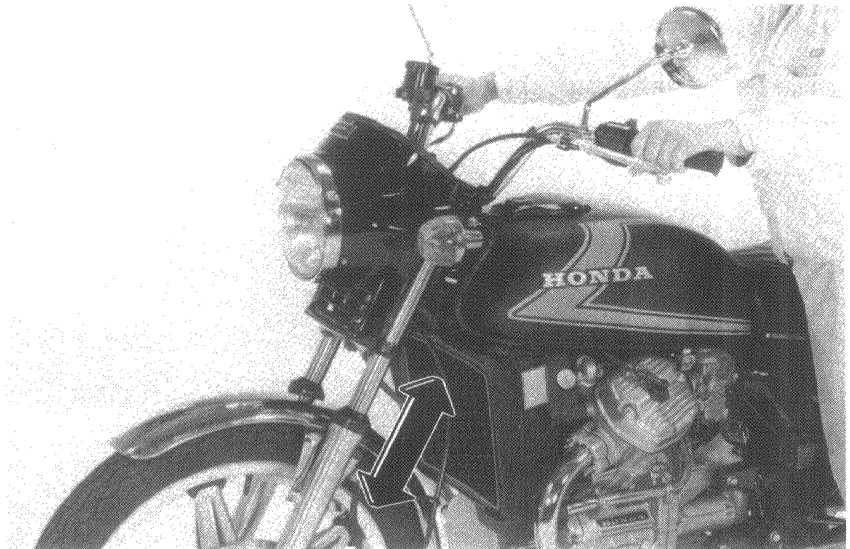

• REAR

Place the motorcycle on a support to raise the rear wheel.

Move the rear wheel sideways with force to see if the swing arm bushings are worn. Replace if excessively worn.

Inspect the entire suspension assembly to be sure it is securely mounted and not damaged or distorted.

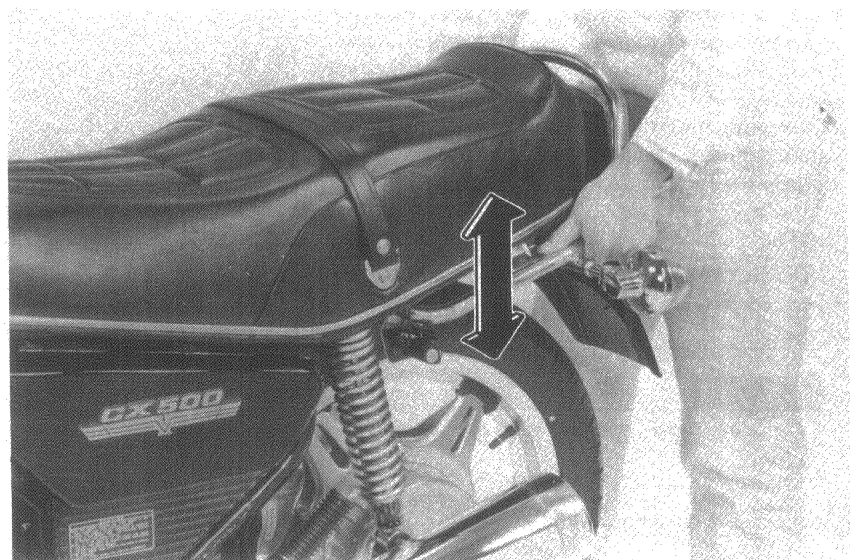



WHEELS

• TIRE PRESSURE

NOTE

Tire pressure should be checked when the tires are COLD.

Check the tires for cuts, imbedded nails or other sharp objects.

Cold tire pressures kg/cm ² (psi)	Up to 90 kg (200 lb) load	Front: 1.75 (25) Rear : 2.0 (28)
	Up to vehicle Capacity load	Front: 1.75 (25) Rear : 2.5 (36)
Vehicle capacity load limit	150 kg (330 lbs)	
Tire size	Front: 3.25S19-4PR Rear : 3.75S18-4PR	
Tire brand	Front: YOKOHAMA Y-992 BRIDGESTONE S703 TUBELESS ONLY Rear : YOKOHAMA Y-987 BRIDGESTONE S21-R2 TUBELESS ONLY	

Check the front and rear wheels for trueness.
(Section 13, 14)

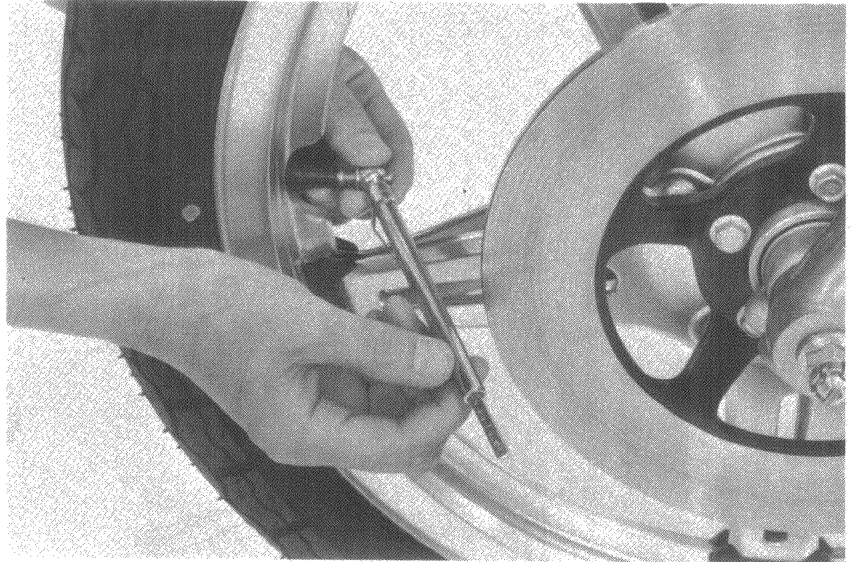

STEERING HEAD BEARING

NOTE

Check that the control cables do not interfere with the rotation of the handlebars.

Raise the front wheel off the ground.
Check that the handlebar rotates freely.
If the handlebar moves unevenly, binds, or has vertical movement, adjustment is necessary.
Adjust the steering head bearing by turning the steering head adjusting nut with a pin spanner.



NUTS, BOLTS, FASTENERS

Check that all chassis nuts, bolts and fasteners are tightened to their correct torque values.
See page 1-4.